

Data Sheet for Precision Potentiometer

Multiturn Hybrid Potentiometer

Series HHS17



The HHS17 potentiometers in 22 mm housing are suitable for applications where a long life span and very high-resolution multiturn potentiometer with servo flange is important.

- Very high-resolution, long-lasting and clean signal
- No winding jumps due to hybrid technology
- Optional version HHS17xxR with slipping clutch
- With many options

The high-resolution precision potentiometers of the HHS17 series have a wire-wound resistor element, which is finished with a conductive plastic layer. Thus the so-called winding jumps are omitted and the resolution is almost infinite. Due to the smooth surface of the resistance element, the hybrid potentiometer has a significantly longer life span and qualifies it as a position feedback in closed loop control circuits. In addition, an optional integrated slipping clutch protects the potentiometer from damage by overrunning the end stops and facilitates the zero point adjustment. The potentiometer is available in a 3, 5 or 10 turn version. The radial gold-plated connection pins are suitable for flat connectors (2.8 mm according to DIN 46247 part 3).

Electrical Data	3-turn	5-turn	10-turn
Effective electrical angle of rotation 1.)	1080° ±5°	1800° ±5°	3600° ±5°
Total resistance 1.)	1..50 kOhm		2..100 kOhm
Resistance tolerance	±5%		±10% (±5%)
Independent linearity (best straight line) 1.)	±0.25% (±0.2%)		±0.25% (±0.1%)
Theoretical resolution 1.)	Nearly infinite		
Backlash (Hysteresis) 1.)	≤ 2°		
Max. / recommended wiper current 1.)	10 µA / 2 µA		
Power rating @ 70°C (0W @ 105°C)	0.5 W	1 W	2 W
Insulation Voltage 1.)	1000 VAC, 1min		
Insulation Resistance 1.)	100 MOhm @ 1000 VDC		

Mechanical Data, Environmental Conditions, Miscellaneous	3-turn	5-turn	10-turn
Mechanical angle of rotation	1080° +10°	1800° +10°	3600° +10°
Lifetime (90% el. eff. angle half sine) 2.)	1.5 mio. rotations	2.5 mio. rotations	5 mio. rotations
Max. operational speed	40 rev. / min.		
Bearing	Ball bearing front, sintered bearing rear side		
Operational torque @ ambient temperature 1.) 2.)	5 Nmm		
End stop torque 1.) 2.)	35 Ncm		
Operating temperature range	-55 °C up to +105 °C		
Storage temperature range	-55 °C up to +105 °C		
Protection grade (IEC 60529)	IP40		
Vibration (IEC 68-2-6, Test Fc)	15g 10Hz to 2000Hz x 12h		
Shock (IEC 68-2-27, Test Ea)	49g bei 11 ms x 18		
Housing diameter	22 mm		
Housing depth	22 mm		
Shaft diameter	3.175 mm		
Shaft type	Solid shaft		

Data Sheet for Precision Potentiometer

Multiturn Hybrid Potentiometer

Series HHS17

Mechanical Data, Environmental Conditions, Miscellaneous	3-turn	5-turn	10-turn
Max. radial load	≤1 N		
Max. axial load	≤1 N		
Connection type	Gold plated soldering lugs		
Connection position	Radial		
Sensor mounting	Servo flange		
Mass	30 g		
Fastening parts included in delivery	3 x servo clamps SFN2 with screw M3 x 7.5		
Material shaft	Stainless steel		
Material housing	Plastic		

1.) According IEC 60393

2.) Determined by climatic conditions according to IEC 68-1, para. 5.3.1 without load collectives

Please note: Max. permissible supply voltage <75 VDC respectively <50 VAC in addition the max. power rating must be observed

Data Sheet for Precision Potentiometer

Multiturn Hybrid Potentiometer

Series HHS17

Order code

Description	Selection: standard=black/bold , possible <i>options=grey/italic</i>							
Series	HHS17							
Revolutions with stop:								
<i>Option 3-turn</i>		03						
<i>Option 5-turn</i>		05						
10-turn		10						
Slipping clutch:								
Without additional mechanics			-					
<i>Option with integrated slipping clutch</i>			R					
Resistance value:					<i>Tandem</i>			
<i>Option 1 kOhm (only 3 and 5 turn)</i>				R1k	/1k			
<i>Option 2 kOhm</i>				R2k	/2k			
5 kOhm				R5k	/5K			
10 kOhm				R10k	/10K			
<i>Option 20 kOhm</i>				R20K	/20K			
<i>Option 50 kOhm</i>				R50K	/50k			
<i>Option 100 kOhm (only 10 turn)</i>				R100K	/100k			
Resistance tolerance:								
±10% (10 turn)						W10%		
±5% (3+5 turn) / Option ±5% (10 turn)						W5%		
Independent linearity:								
±0,25%							L0,25%	
<i>Option ±0,2% (only 3 and 5-turn)</i>							L0,2%	
<i>Option ±0,1% (only 10-turn)</i>							L0,1%	
<i>Option center tap only 10 turn:</i>								CT
Front shaft:								
Standard Ø3,175 x 9,6 mm								-
<i>Option shaft length in mm</i>								Ax,xx
<i>Option shaft diameter in mm (≤6,35 mm)</i>								DMx,xx

For higher quantities or on-going demand, additional options are available as described below on request

For Example: Special electrical and mechanical angles of rotation, and special resistance and linearity tolerances. Furthermore we can mount gear wheels or attach cable assemblies with or without connectors and much more.

Data Sheet for Precision Potentiometer



Multiturn Hybrid Potentiometer

Series HHS17

Drawing

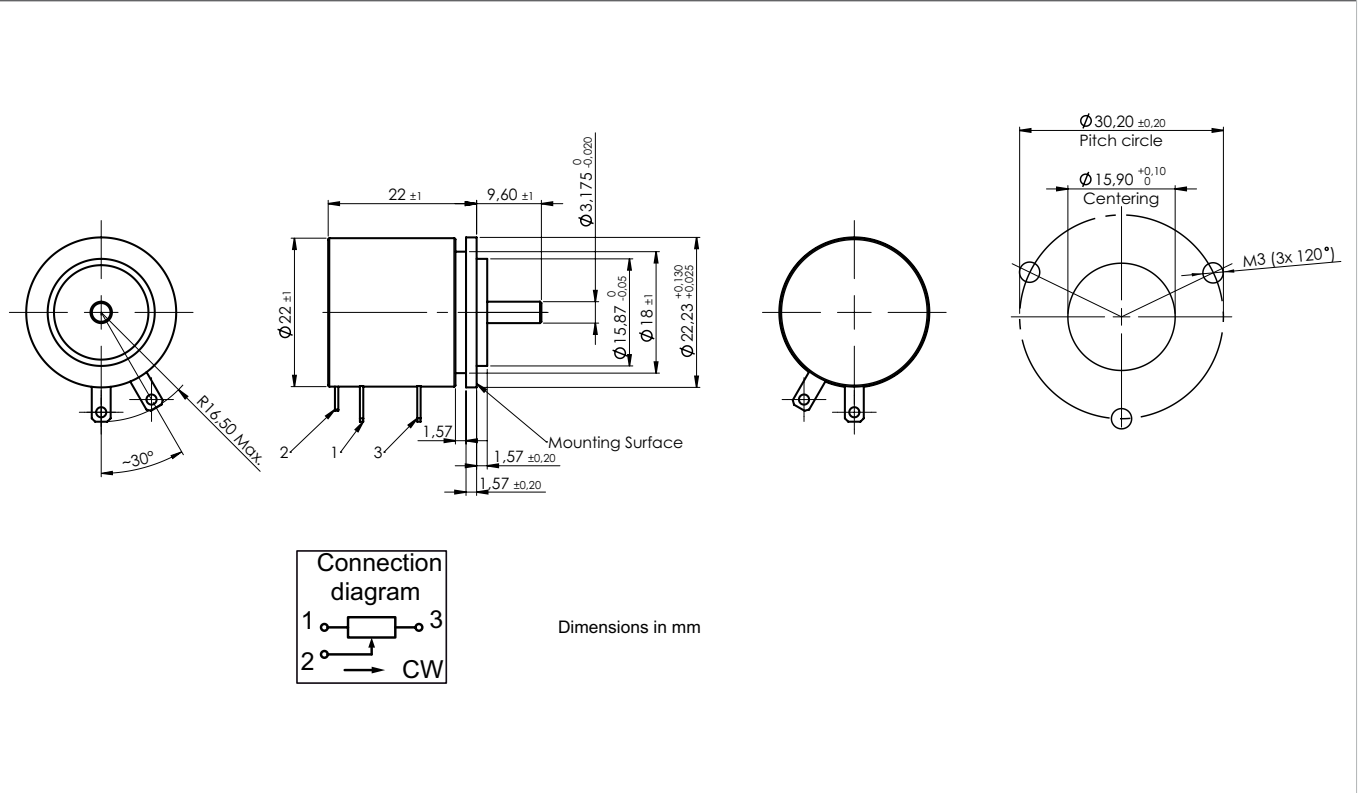

On Request: Special machining on shaft

Slot



Groove



Flat



Round top

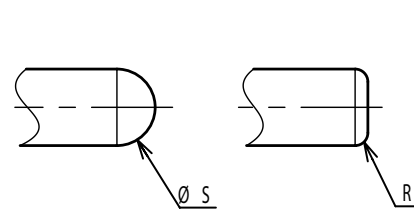

Double side flat

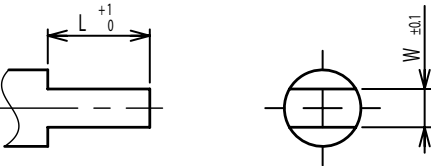

Counterbore hole

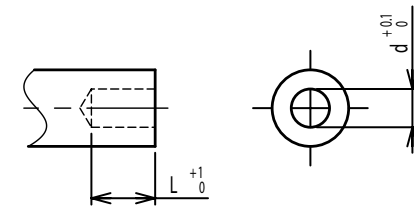

Step

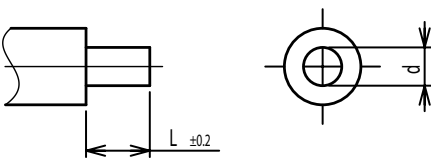

Counterbore screw hole

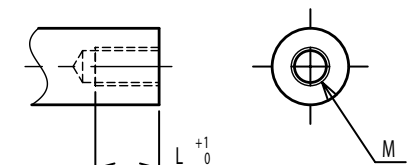

Screw Thread

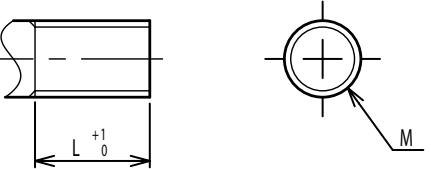

Pin hole

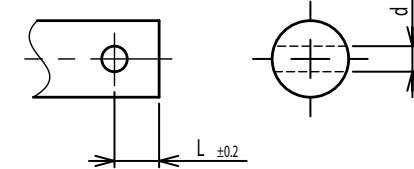

Knurled(Parallel)

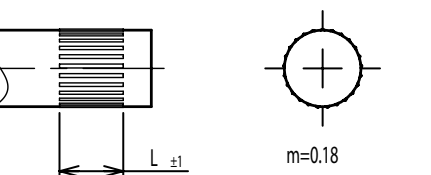

Screw thread inside hole

