

Data Sheet for Precision Potentiometer

Oil-filled singleturn wirewound Potentiometer

Series OF5001



OF5001 potentiometers are filled with oil. The oil has a heat dissipating function, cleans the resistance element from abrasion and protects it from moisture and aggressive substances.

- Optional center tap
- Optional without mech. stop
- Optional tandem version
- Optional rear shaft
- On request with higher lifespan >2 mio. rotations
- On request with centering collar

Electrical Data

Effective electrical angle of rotation 1.)	280° ±5°
Total resistance 1.)	100 Ohm..50 kOhm
Resistance tolerance	±5%
Independent linearity (best straight line) 1.)	±0.5%
Theoretical resolution 1.)	Depends on resistance value (see table below)
Backlash (Hysteresis) 1.)	≤ 0.5°
Rotational noise (ENR) 1.) (Method C)	100 Ohm
Max. / recommended wiper current 1.)	35 mA / 2 µA
Power rating @ 40°C (0W @ 60°C)	5 W
Insulation Voltage 1.)	1000 VAC. 1min
Insulation Resistance 1.)	100 MOhm @ 1000 VDC

Mechanical Data, Environmental Conditions, Miscellaneous

Mechanical angle of rotation	300° ±5° with stop (optional without stop 360°)
Lifetime (90% el. eff. angle half sine) 2.)	0.2 Mio. rotations
Max. operational speed	40 rev. / min.
Bearing	Sleeve bearing
Operational torque @ ambient temperature 1.) 2.)	30 Nmm
End stop torque 1.) 2.)	90 Ncm
Operating temperature range	-30 °C up to +60 °C
Storage temperature range	-30 °C up to +60 °C
Protection grade (IEC 60529)	IP65
Vibration (IEC 68-2-6, Test Fc)	15g 10Hz to 2000Hz x 12h
Shock (IEC 68-2-27, Test Ea)	49g @ 11 ms x 18
Housing diameter	62 mm
Housing depth	50 mm
Shaft diameter	6 mm (optional 6.35 mm)
Shaft type	Solid shaft

Data Sheet for Precision Potentiometer

Oil-filled singleturn wirewound Potentiometer

Series OF5001

Mechanical Data, Environmental Conditions, Miscellaneous

Max. radial load	≤1 N
Max. axial load	≤1 N
Connection type	Soldering lugs
Connection position	Axial
Sensor mounting	Bushing
Mass	300 g
Fastening parts included in delivery	Nut, toothed washer
Fastening torque mounting nut	150 Ncm
Material shaft	Stainless steel
Material housing	Metal

1.) According IEC 60393

2.) Determined by climatic conditions according to IEC 68-1, para. 5.3.1 without load collectives

Please note: Max. permissible supply voltage <75 VDC respectively <50 VAC in addition the max. power rating must be observed

Number of wire turns / resolution

Resistance value Ohm	100	200	500	1k	2k	5k	10k	20k	50k
Number of wire turns	260	320	370	420	550	650	900	1000	1200

Resolution in degree E.g. R5k = $280^\circ / 650 = 0,430^\circ$ per winding resistive wire

Data Sheet for Precision Potentiometer

Oil-filled singleturn wirewound Potentiometer

Series OF5001

Order code

Description	Selection: standard=black/bold , possible <i>options=grey/italic</i>									
Series	OF5001									
Angle of rotation mecha.: With stop		-								
<i>Option without stop</i>		OS								
Resistance value / Option Tandem:				<i>Tandem</i>						
<i>Option 100 Ohm</i>			R100	/100						
<i>Option 200 Ohm</i>			R200	/200						
<i>Option 500 Ohm</i>			R500	/500						
1 kOhm			R1k	/1k						
<i>Option 2 kOhm</i>			R2k	/2k						
5 kOhm			R5k	/5K						
10 kOhm			R10k	/10K						
<i>Option 20 kOhm</i>			R20k	/20K						
<i>Option 50 kOhm</i>			R50k	/50k						
<i>Option rear shaft: Standard Ø6.00 x 25 mm Shaft length in mm Shaft diameter in mm (≤6 mm)</i>						RA RAxx,xx RADMx,xx				
Resistance tolerance: ±5%							W5%			
Independent linearity: ±0.5%								L0,5%		
<i>Option center tap:</i>									CT	
Front shaft: Standard Ø6.00 x 25 mm										
<i>Option Ø6.35 mm</i>									-	
<i>Option shaft length in mm</i>									DM6,35	
<i>Option shaft diameter in mm (≤6.35 mm)</i>									Ax,xx	
<i>Option screwdriver slot:</i>									DMx,xx	B

For higher quantities or on-going demand, additional options are available as described below on request

For Example: Life span > 2 mio. rotations and centering collar 5/8" (type 4575C), multi ganged potentiometers, special electrical and mechanical angles of rotation, and special resistance and linearity tolerances. Furthermore we can mount gear wheels or attach cable assemblies with or without connectors and much more.

Data Sheet for Precision Potentiometer



Oil-filled singleturn wirewound Potentiometer

Series OF5001

Drawing

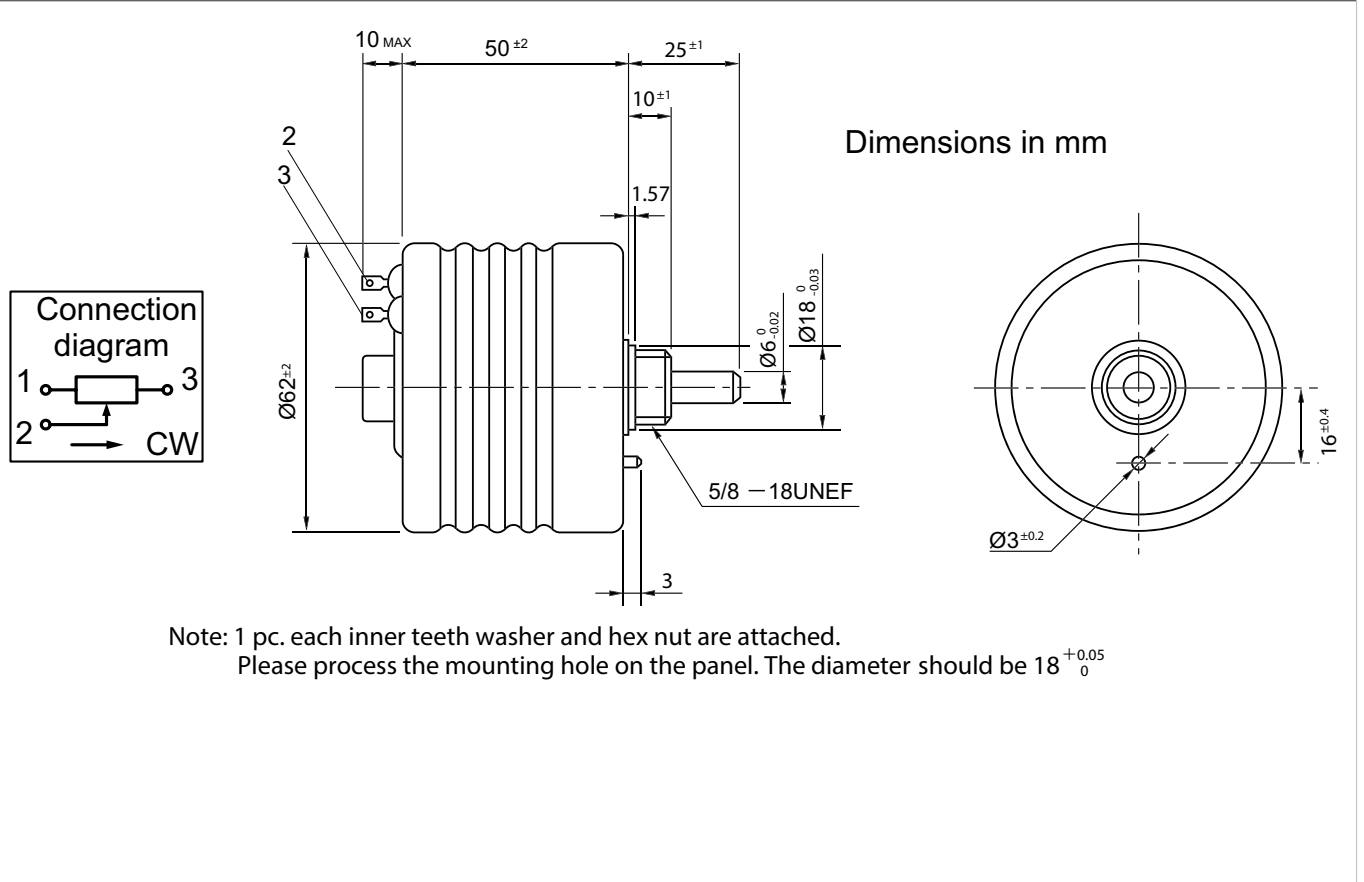

On Request: Special machining on shaft

Slot



Groove

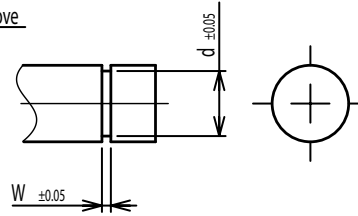

Flat

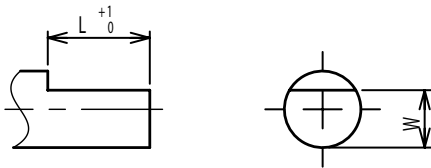

Round top

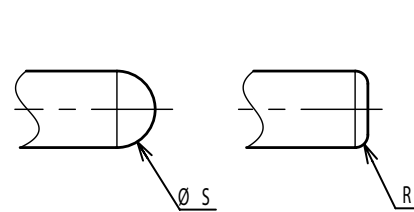

Double side flat

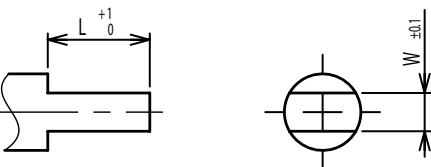

Counterbore hole

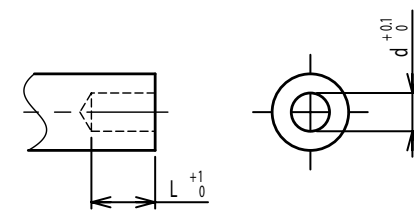

Step



Counterbore screw hole

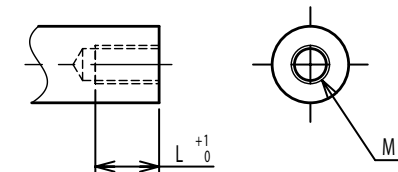

Screw Thread

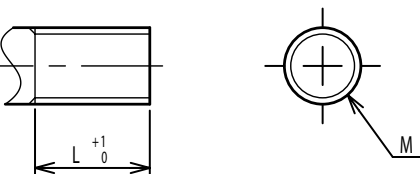

Pin hole

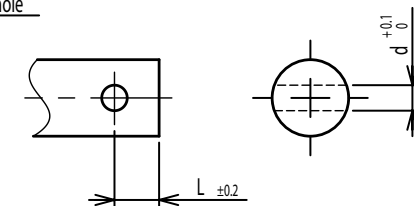

Knurled(Parallel)



Screw thread inside hole

